

JH. Living Vocoder
 (c) J. Haible 2010
 All Rights reserved
 Errors excepted

Channel 5

Channel Level LED Cathode
 Channel Level LED Anode
 Channel CV Output (negative voltage!)

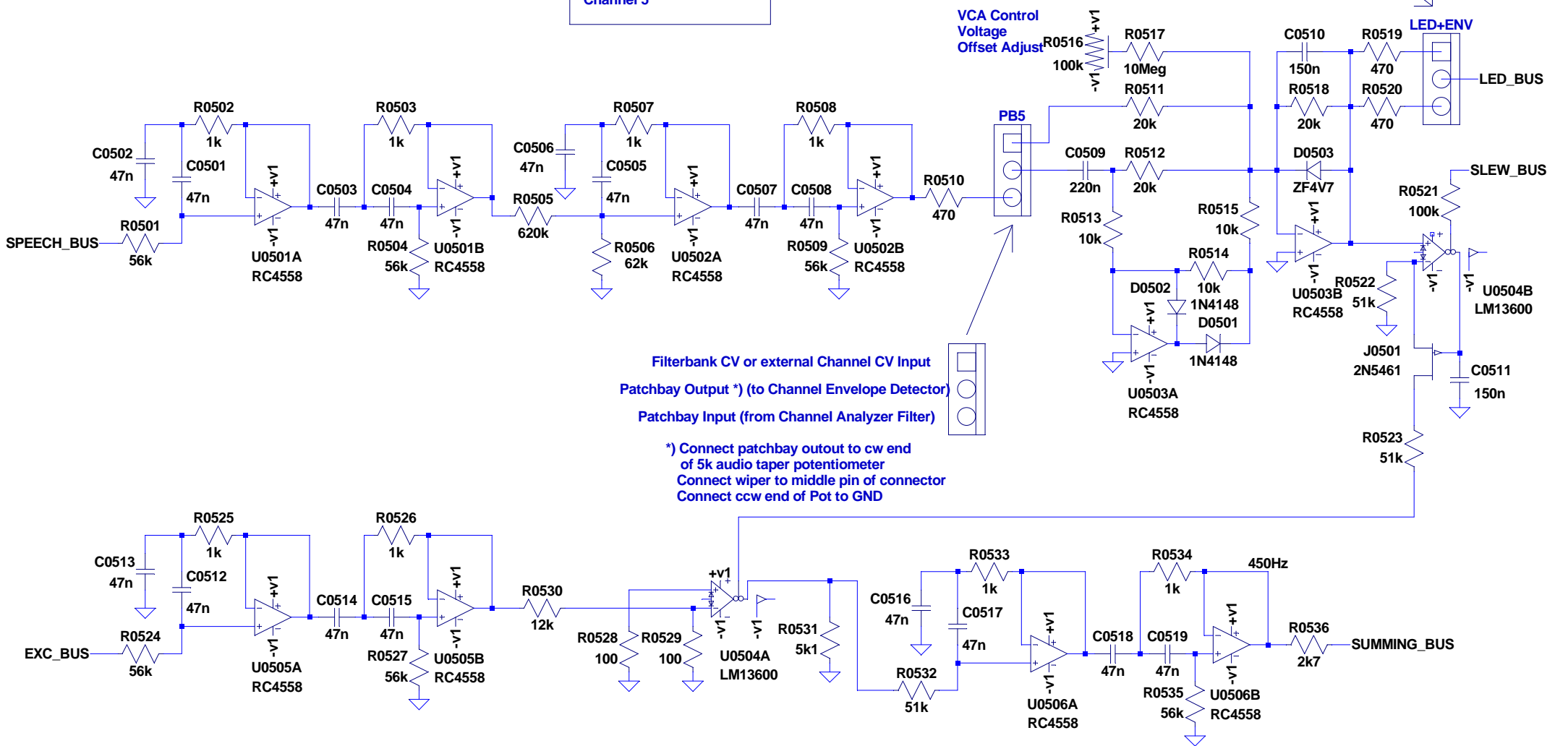

Filterbank CV or external Channel CV Input
 Patchbay Output *) (to Channel Envelope Detector)
 Patchbay Input (from Channel Analyzer Filter)

*) Connect patchbay output to cw end of 5k audio taper potentiometer
 Connect wiper to middle pin of connector
 Connect ccw end of Pot to GND